

### High Pressure filters

#### In-line

**Maximum working pressure up to 42 MPa (420 bar)**

**Flow rate up to 750 l/min**

FHP is a range of versatile high pressure filter for protection of sensitive components in high pressure hydraulic systems in the industrial equipment.

They are directly connected to the lines of the system through the hydraulic fittings.

#### Available features:

- Female threaded connections up to 1 1/2" and flanged connections up to 2", for a maximum return flow rate of 750 l/min
- Fine filtration rating, to get a good cleanliness level into the system
- Bypass valve, to relieve excessive pressure drop across the filter media
- Check valve, to protect the system against reverse flow
- Reverse flow valve, to allow bidirectional flow through the filter housing. The back flow is not filtered. The filter requires the use of internal check valves to direct the flow through the element in one direction and around the element in the other
- Low collapse filter element "N", for use with filters provided with bypass valve
- High collapse filter element "H", for use with filters not provided with bypass valve
- Low collapse filter element with external support "R", for filter element protection against the back pressure caused by the check valve or the reverse flow in filters provided with the bypass valve
- High collapse filter element with external support "S", for filter element protection against the back pressure caused by the check valve or the reverse flow in filters not provided with the bypass valve
- Visual, electrical and electronic differential clogging indicators

#### Common applications:

Delivery lines, in any high pressure industrial equipment or mobile machines

#### Filter housing materials

- Head: Phosphatized cast iron
- Housing: Phosphatized steel
- Bypass valve  
AISI 316L: FHP 010 - 011  
Brass: FHP 065 - 135  
Brass / AISI 304: FHP 350  
Steel: FHP 500
- Reverse Flow  
Steel: FHP 350 - FHP 500

- Check valve: Steel

#### Pressure

- Test pressure: 63 MPa (630 bar)
- Burst pressure: 126 MPa (1260 bar)
- Pulse pressure fatigue test: 1 000 000 cycles with pressure from 0 to 42 MPa (420 bar)

#### Bypass valve

- Opening pressure 600 kPa (6 bar) ±10%
- Other opening pressures on request.

#### Δp element type

- Microfibre filter elements - series N: 20 bar
- Microfibre filter elements - series R: 20 bar (not available for FHP 010-011 and FHP 500)
- Microfibre filter elements - series H: 210 bar
- Microfibre filter elements - series S: 210 bar (only for FHP 500)
- Wire mesh filter elements - series N: 20 bar
- Fluid flow through the filter element from OUT to IN

#### Seals

- Standard NBR series A
- Optional FPM series V

#### Temperature

From -25 °C to +110 °C

#### Connections

FHP 010 - 065 - 135 - 350 - 500:

In-line Inlet/Outlet

FHP 011:

90° Inlet/Outlet

#### Note

FHP filters are provided for vertical mounting



## Weights [kg] and volumes [dm<sup>3</sup>]

Filter series	Weights [kg]					Volumes [dm <sup>3</sup> ]						
	Length	1	2	3	4	5	Length	1	2	3	4	5
<b>FHP 010 - 011</b>		2.05	2.18	2.64	3.13	-		0.10	0.12	0.15	0.20	-
<b>FHP 065</b>		4.26	4.62	5.83	-	-		0.25	0.30	0.50	-	-
<b>FHP 135</b>		7.11	8.71	9.76	-	-		0.43	0.76	0.97	-	-
<b>FHP 350</b>		13.95	16.08	18.37	20.85	-		1.00	1.72	2.49	3.32	-
<b>FHP 500</b>		27.00	31.17	34.69	46.70	52.5		1.71	2.43	3.04	5.18	6.51

Filter series	Length	Filter element design - H Series					Filter element design - N Series					
		A03	A06	A10	A16	A25	A03	A06	A10	A16	A25	M25
<b>FHP 010</b>	<b>1</b>	3	5	6	7	8	4	6	8	9	10	37
	<b>2</b>	5	7	13	16	22	6	8	16	19	24	40
	<b>3</b>	10	13	22	25	30	11	14	23	26	31	41
	<b>4</b>	12	15	25	27	32	16	19	27	30	33	41
<b>FHP 011</b>	<b>1</b>	3	5	6	7	9	4	6	8	9	11	47
	<b>2</b>	5	7	14	17	24	7	9	17	21	28	52
	<b>3</b>	11	14	25	29	36	11	14	26	30	37	53
	<b>4</b>	12	16	28	32	38	17	21	32	36	40	54
<b>FHP 065</b>	<b>1</b>	24	25	50	59	84	25	33	56	63	90	142
	<b>2</b>	33	38	68	77	98	34	52	72	79	106	143
	<b>3</b>	61	70	100	107	123	61	73	101	108	125	147
<b>FHP 135</b>	<b>1</b>	49	55	95	98	147	67	72	115	122	159	184
	<b>2</b>	89	106	129	131	163	105	111	140	142	192	209
	<b>3</b>	120	132	158	166	180	141	143	176	179	193	211
<b>FHP 350</b>	<b>1</b>	108	115	188	197	301	127	140	234	282	343	451
	<b>2</b>	196	225	317	323	396	256	278	394	415	465	480
	<b>3</b>	266	310	384	392	440	331	370	450	466	475	490
	<b>4</b>	308	333	391	398	445	369	393	456	474	495	503
<b>FHP 500</b>	<b>1</b>	144	157	265	268	355	269	305	390	406	444	612
	<b>2</b>	232	262	350	363	398	321	357	433	441	484	619
	<b>3</b>	293	301	398	408	455	396	416	497	499	537	622
	<b>4</b>	336	377	452	455	507	430	475	516	524	545	626
	<b>5</b>	420	428	494	500	544	475	493	535	545	569	627

### Maximum flow rate for a complete pressure filter with a pressure drop $\Delta p = 1.5$ bar.

The reference fluid has a kinematic viscosity of 30 mm<sup>2</sup>/s (cSt) and a density of 0.86 kg/dm<sup>3</sup>.

For different pressure drop or fluid viscosity we recommend to use our selection software available on [www.mpfiltri.com](http://www.mpfiltri.com).

You can also calculate the right size using the formulas present on the FILTER SIZING paragraph at the beginning of the full catalogue or at the beginning of the filter family brochure.

Please, contact our Sales Department for further additional information.

### Hydraulic symbols

Filter series	Style S	Style B	Style T	Style D	Style V	Style Z
<b>FHP 010 - 011</b>	•	•			•	•
<b>FHP 065</b>	•	•	•			
<b>FHP 135</b>	•	•	•			
<b>FHP 350</b>	•	•	•	•	•	•
<b>FHP 500</b>	•	•	•	•	•	•

## Pressure drop

### Filter housings $\Delta p$ pressure drop

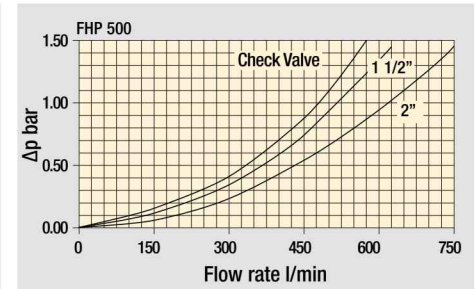
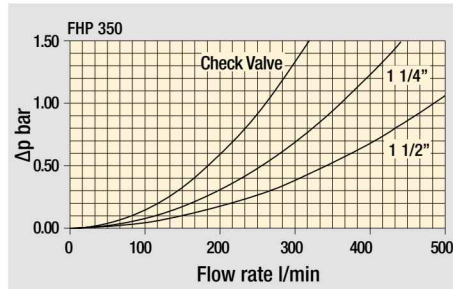
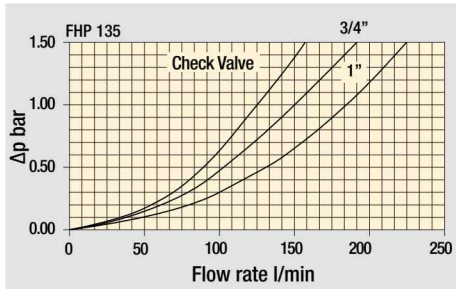
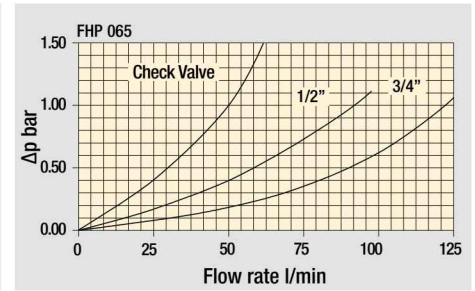
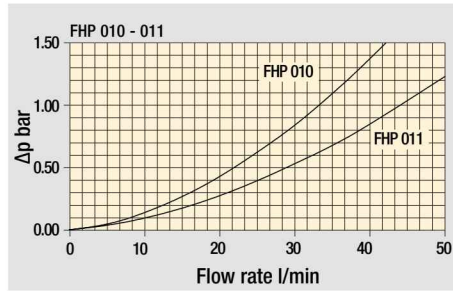

### Bypass valve pressure drop

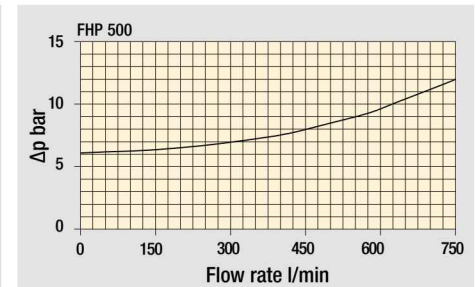
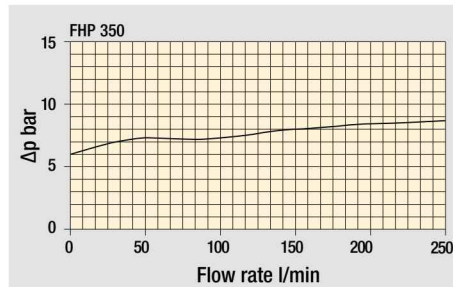
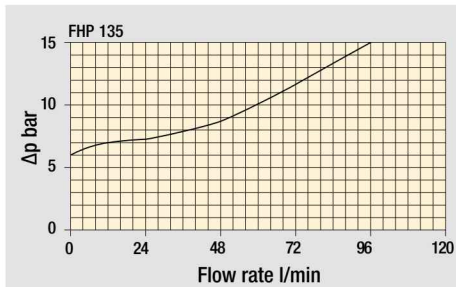
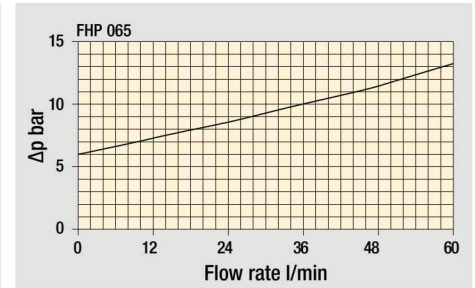
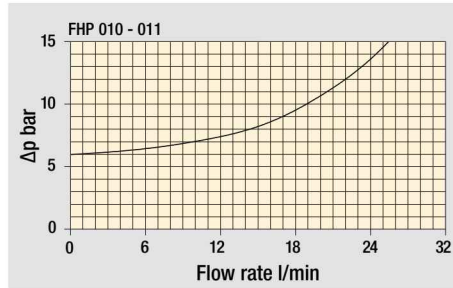

### Valves

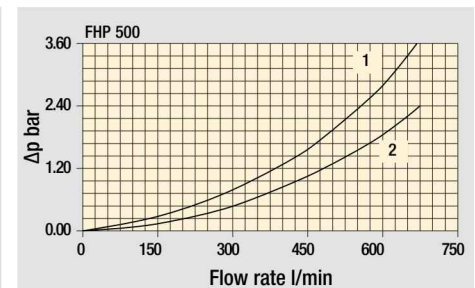
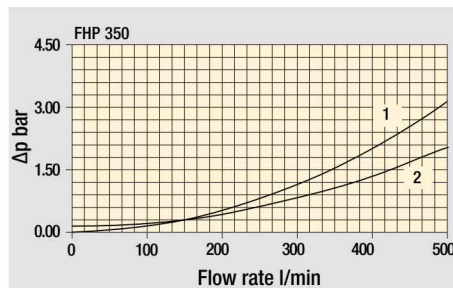
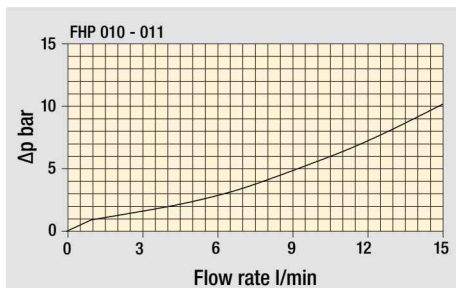

Filter housing with check valve

Pressure drop with reverse flow valve in  
1 - Filtering direction  
2 - Opposite direction

Pressure drop with reverse flow valve in  
1 - Opposite direction  
2 - Filtering direction

The curves are plotted using mineral oil with density of 0.86 kg/dm<sup>3</sup> in compliance with ISO 3968.  $\Delta p$  varies proportionally with density.

# FHP FHP065 - FHP135

## Designation & Ordering code

### COMPLETE FILTER

Series and size Configuration example: **FHP135** **2** **B** **A** **G3** **A06** **S** **P01**

**FHP065** | **FHP135**

Length
1
2
3

Valves
<b>S</b> Without bypass
<b>B</b> With bypass 6 bar
<b>T</b> With check valve, without bypass

Seals
<b>A</b> NBR
<b>V</b> FPM

Connections	FHP065	FHP135
<b>G1</b>	G 1/2"	G 3/4"
<b>G2</b>	G 3/4"	G 1"
<b>G3</b>	1/2" NPT	3/4" NPT
<b>G4</b>	3/4" NPT	1" NPT
<b>G5</b>	SAE 8 - 3/4" - 16 UNF	SAE 12 - 1 1/16" - 12 UN
<b>G6</b>	SAE 12 - 1 1/16" - 12 UN	SAE 16 - 1 5/16" - 12 UN
<b>F1</b>	-	3/4" SAE 3000 psi/M
<b>F2</b>	-	1" SAE 3000 psi/M
<b>F3</b>	-	3/4" SAE 3000 psi/UNC
<b>F4</b>	-	1" SAE 3000 psi/UNC
<b>F5</b>	-	3/4" SAE 6000 psi/M
<b>F6</b>	-	3/4" SAE 6000 psi/UNC

Filtration rating (filter media)		
<b>A03</b>	Inorganic microfiber	3 µm
<b>A06</b>	Inorganic microfiber	6 µm
<b>A10</b>	Inorganic microfiber	10 µm
<b>A16</b>	Inorganic microfiber	16 µm
<b>A25</b>	Inorganic microfiber	25 µm
<b>M25</b>	Wire mesh	25 µm

Element Δp	Valves						
	S	B	T	D	V	Z	
<b>N</b> 20 bar		•					
<b>R</b> 20 bar				•		•	
<b>H</b> 210 bar	•						
<b>S</b> 210 bar			•		•		

Execution
<b>P01</b> MP Filtri standard
<b>Pxx</b> Customized

### FILTER ELEMENT

Element series and size Configuration example: **HP135** **2** **A06** **A** **S** **P01**

**HP065** | **HP135**

Element length
1
2
3

Filtration rating (filter media)			
<b>A03</b>	Inorganic microfiber	3 µm	<b>A16</b> Inorganic microfiber 16 µm
<b>A06</b>	Inorganic microfiber	6 µm	<b>A25</b> Inorganic microfiber 25 µm
<b>A10</b>	Inorganic microfiber	10 µm	<b>M25</b> Wire mesh 25 µm

Seals
<b>A</b> NBR
<b>V</b> FPM

Element Δp
<b>N</b> 20 bar
<b>R</b> 20 bar
<b>H</b> 210 bar
<b>S</b> 210 bar

Execution
<b>P01</b> MP Filtri standard
<b>Pxx</b> Customized

### ACCESSORIES

Differential indicators	page		page
<b>DEA</b> Electrical differential indicator	567	<b>DLE</b> Electrical / visual differential indicator	570
<b>DEH</b> Hazardous area electronic differential indicator	567-568	<b>DTA</b> Electronic differential indicator	571
<b>DEM</b> Electrical differential indicator	568-569	<b>DVA</b> Visual differential indicator	571
<b>DLA</b> Electrical / visual differential indicator	569-570	<b>DVM</b> Visual differential indicator	571

Additional features	page
<b>T2</b> Plug	572

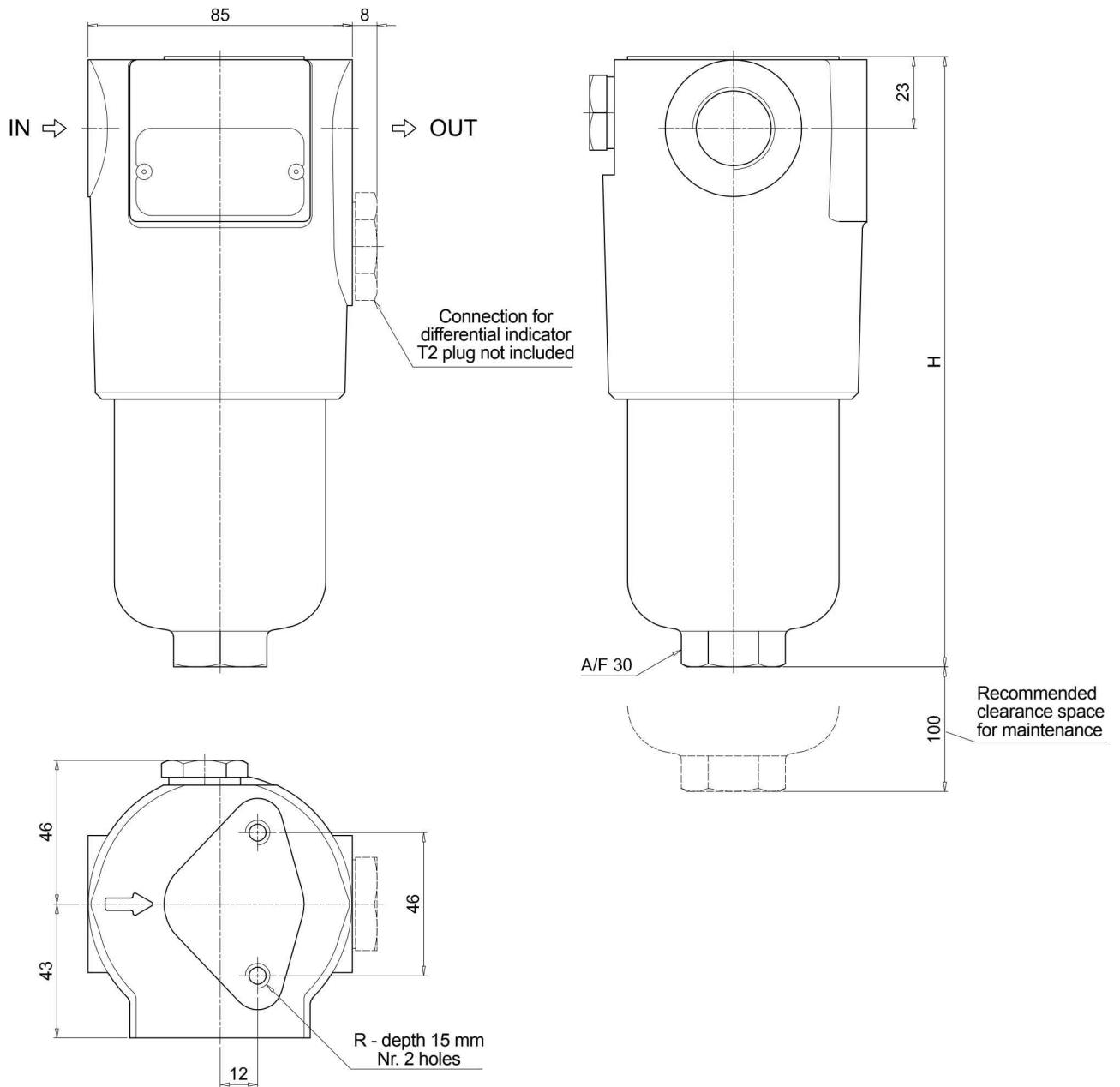

### FHP065

Filter length	H [mm]
1	196
2	227
3	329

Connections	R
G1-G2	M8
G3-G4-G5-G6	5/16" UNC

# FHP FHP065 - FHP135

## Dimensions

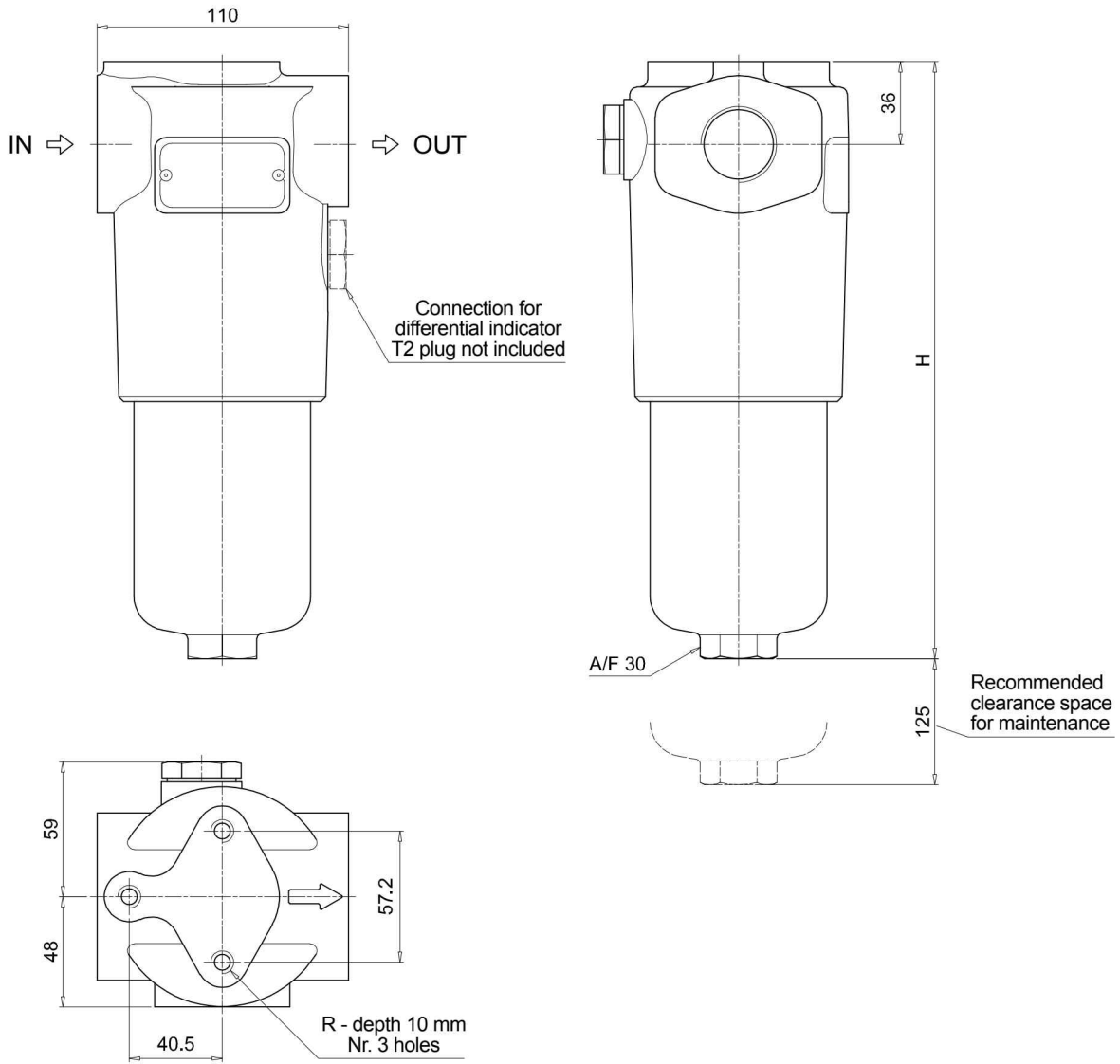

### FHP135

Filter length	H [mm]
<b>1</b>	260
<b>2</b>	373
<b>3</b>	448

Connections	R
<b>G1-G2</b>	M10
<b>G3-G4-G5-G6</b>	3/8" UNC
<b>F1-F2</b>	M10
<b>F3-F4</b>	3/8" UNC
<b>F5</b>	M10
<b>F6</b>	3/8" UNC